



McIntosh Laboratory, Inc. 2 Chambers Street Binghamton, New York 13903-2699 Phone: 607-723-3512 www.mcintoshlabs.com

D100
Digital Preamplifier
Owner's Manual



The lightning flash with arrowhead, within an equilateral triangle, is intended to alert the user to the presence of uninsulated “dangerous voltage” within the product’s enclosure that may be of sufficient magnitude to constitute a risk of electric shock to persons.

WARNING - TO REDUCE RISK OF FIRE OR ELECTRICAL SHOCK, DO NOT EXPOSE THIS EQUIPMENT TO RAIN OR MOISTURE.



AVIS RISQUE DE CHOC ELECTRIQUE - NE PAS OUVRIR.

NO USER-SERVICEABLE PARTS INSIDE. REFER SERVICING TO QUALIFIED PERSONNEL.

The exclamation point within an equilateral triangle is intended to alert the user to the presence of important operating and maintenance (servicing) instructions in the literature accompanying the appliance.

To prevent the risk of electric shock, do not remove cover or back. No user-serviceable parts inside.

IMPORTANT SAFETY INSTRUCTIONS!

PLEASE READ THEM BEFORE OPERATING THIS EQUIPMENT.

1. Read these instructions.
2. Keep these instructions.
3. Heed all warnings.
4. Follow all instructions.
5. Do not use this apparatus near water.
6. Clean only with a dry cloth.
7. Do not block any ventilation openings. Install in accordance with the manufacturer’s instructions.
8. Do not install near any heat sources such as radiators, heat registers, stoves, or other apparatus (including amplifiers) that produce heat.
9. Do not defeat the safety purpose of the polarized or grounding-type plug. A polarized plug has two blades with one wider than the other. A grounding type plug has two blades and a

third grounding prong. The wide blade or the third prong are provided for your safety. If the provided plug does not fit into your outlet, consult an electrician for replacement of the obsolete outlet.

10. Protect the power cord from being walked on or pinched particularly at plugs, convenience receptacles, and the point where they exit from the apparatus.
11. Only use attachments/accessories specified by the manufacturer.
12. Use only with the cart, stand, tripod, bracket, or table specified by the manufacturer, or sold with the apparatus. When a cart is used, use caution when moving the cart/apparatus combination to avoid injury from tip-over.
13. Unplug this apparatus during lightning storms or when unused for long periods of time.
14. Refer all servicing to qualified service personnel. Servicing is required when the apparatus has been damaged in any way, such as power-



supply cord or plug is damaged, liquid has been spilled or objects have fallen into the apparatus, the apparatus has been exposed to rain or moisture, does not operate normally, or has been dropped.

15. Do not expose this equipment to dripping or splashing and ensure that no objects filled with liquids, such as vases, are placed on the equipment.
16. To completely disconnect this equipment from the a.c. mains, disconnect the power supply cord plug from the a.c. receptacle.
17. The mains plug of the power supply cord shall remain readily operable.
18. Do not expose batteries to excessive heat such as sunshine, fire or the like.
19. Connect mains power supply cord only to a mains socket outlet with a protective earthing connection.

Thank You

Your decision to own this McIntosh D100 Digital Pre-amplifier ranks you at the very top among discriminating music listeners. You now have “The Best.” The McIntosh dedication to “Quality,” is assurance that you will receive many years of musical enjoyment from this unit.

Please take a short time to read the information in this manual. We want you to be as familiar as possible with all the features and functions of your new McIntosh.

Please Take A Moment

The serial number, purchase date and McIntosh Dealer name are important to you for possible insurance claim or future service. The spaces below have been provided for you to record that information:

Serial Number: _____

Purchase Date: _____

Dealer Name: _____

Technical Assistance

If at any time you have questions about your McIntosh product, contact your McIntosh Dealer who is familiar with your McIntosh equipment and any other brands that may be part of your system. If you or your Dealer wish additional help concerning a suspected problem, you can receive technical assistance for all McIntosh products at:

McIntosh Laboratory, Inc.
2 Chambers Street
Binghamton, New York 13903
Phone: 607-723-3512
Fax: 607-724-0549

Customer Service

If it is determined that your McIntosh product is in need of repair, you can return it to your Dealer. You can also return it to the McIntosh Laboratory Service Department. For assistance on factory repair return procedure, contact the McIntosh Service Department at:

McIntosh Laboratory, Inc.
2 Chambers Street
Binghamton, New York 13903
Phone: 607-723-3515
Fax: 607-723-1917

Table of Contents

Safety Instructions	2
Thank You and Please Take a Moment.....	3
Technical Assistance and Customer Service	3
Table of Contents	3
General Information	4
Connector and Cable Information	4
Introduction.....	5
Performance Features	5
Dimensions	6
Installation	7
Connections:	
Rear Panel Connections	8
Connecting to a Power Amplifier	9
Connecting to an Analog Preamplifier or A/V Control Center	10
Connection Diagrams (Separate Sheet)	Mc1A and Mc1B
Remote Control:	
Remote Control Push-buttons.....	11

Front Panel:

Front Panel Displays, Controls, Push-buttons and Jack.....	12
---	----

Setup:

Setup	13
-------------	----

Operation:

How to Operate the D100.....	14-15
------------------------------	-------

Additional Information:

Photos.....	16-17
Specifications.....	18
Packing Instruction.....	19

General Information

1. For additional connection information, refer to the owner's manual(s) for any component(s) connected to the D100 Digital Preamplifier.
2. The Main AC Power going to the D100 and any other McIntosh Component(s) should not be applied until all the system components are connected together. Failure to do so could result in malfunctioning of some or all of the system's normal operations. When the D100 and other McIntosh Components are in their Standby Power Off Mode, the Microprocessor's Circuitry inside each component is active and communication is occurring between them.
3. The Fixed Balanced/Unbalanced Outputs and the variable Balanced/Unbalanced Outputs can be used simultaneously.
4. The D100 internal Digital to Analog Converter Circuitry is designed to decode 2-channel PCM (Pulse Code Modulation) Digital Signal present at the Coaxial, Optical and USB Digital Inputs. Other Digital Audio Signal Format Types will cause the Audio Outputs of the D100 to be muted.
5. The IR Input, with 1/8 inch mini phone jack, is configured for non-McIntosh IR sensors such as a Xantech Model HL85BK Kit.
6. When discarding the unit, comply with local rules or regulations. Batteries should never be thrown away or incinerated but disposed of in accordance with the local regulations concerning battery disposal. 
7. For additional information on the D100 and other McIntosh Products please visit the McIntosh Web Site at www.mcintoshlabs.com.

Connector and Cable Information

XLR Connectors

Below is the Pin configuration for the XLR Balanced Output Connectors on the D100. Refer to the diagram for connections:

- PIN 1: Shield/Ground
- PIN 2: + Output
- PIN 3: - Output

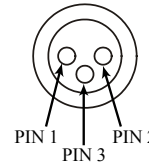

Power Control

The D100 Power Control In receives and the Power Control Out sends Power On/Off Signals (+12 volt/0 volt) when connected to other McIntosh Components. An additional connection is for controlling the illumination of the Power Output Meters on McIntosh Power Amplifiers. A 1/8 inch stereo mini phone plug is used for connection to the Power Control

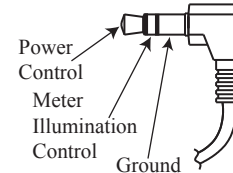

Data Input and IR IN Port Connectors

The D100 Data In Port receives Remote Control Signals from McIntosh Preamplifiers and A/V Control Centers. A 1/8 inch stereo mini phone plug is used for connection.

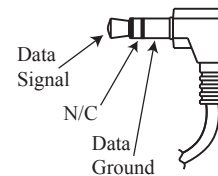

The IR IN Port also uses a 1/8 inch stereo mini phone plug and allows the connection of other brand IR Receivers to the D100.

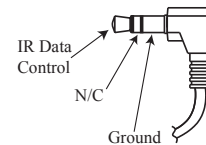

Introduction

The McIntosh D100 Digital Preamplifier is one of the finest Preamplifiers ever created with connections for digital sources. The D100 Outputs have the ability to drive multiple components. The D100 reproduction is sonically transparent and absolutely accurate. The McIntosh Sound is “The Sound of the Music Itself.”

Performance Features

• Dual Function

Use the D100 as the Preamplifier together with McIntosh Source Components and Power Amplifier to form a complete Audio System. Connect the D100 to an existing McIntosh Analog Audio System to provide the latest in Digital-to-Analog Conversion from digital audio sources.

• Electronic Input Switching

Electronic Input Switching on all Inputs provides reliable, noiseless, distortion free switching.

• Digital Audio Inputs

The D100 has Coaxial, Optical and USB Digital Inputs to Decode PCM Signals from an external source. The Coaxial and Optical Inputs process Digital Signals up to 192kHz with 24Bit resolution. The USB Input process Digital Signals up to 192kHz with 32Bit resolution.

• Quad Balanced Digital to Analog Converter

The 8 channel 32-bit, 192kHz Digital to Analog Converter is used in a Stereo Quad Balanced Mode, assuring the music is reproduced with a wide dynamic range and extremely low distortion, for both Disc and external sources.

• Balanced Outputs

The Balanced Outputs allow the connection of long cable lengths without a loss in sound quality.

• Precision Tracking Volume Control

Volume levels are controlled by a new Precision Digitally Controlled Attenuator System with a tracking accuracy of 0.1dB.

• Alphanumeric Fluorescent Display

The Front Panel Information Display indicates the Source Selection, Sampling Frequency, Bit Depth, Volume Level and Setup Mode Selections. The display intensity is adjustable.

• Remote Control with External Sensor Input

The Remote Control provides control of the D100 operating functions and allows enjoy of your McIntosh System from another room in your home by connecting an external sensor.

• Power Control Input and Output

A Power Control connection for convenient Turn-On of McIntosh Power Amplifiers, Source Components and Accessories is included.

• Special Power Supply

Fully regulated Power Supplies and a special R-Core Power Transformer ensure stable noise free operation even though the power line varies.

• Gold Plated Connectors

The Input and Output Connectors Contacts are gold plated for superior corrosion resistance and high electrical conductivity.

• Fiber Optic Solid State Front Panel Illumination

The even Illumination of the Front Panel is accomplished by the combination of custom designed Fiber Optic Light Diffusers and extra long life Light Emitting Diodes (LEDs).

• Glass Front Panel

The famous McIntosh Illuminated Glass Front Panel ensures the pristine beauty of the D100 will be retained for many years.

Dimensions

The following dimensions can assist in determining the best location for your D100. There is additional information on the next page pertaining to installing the D100 into cabinets.

Front View of the D100

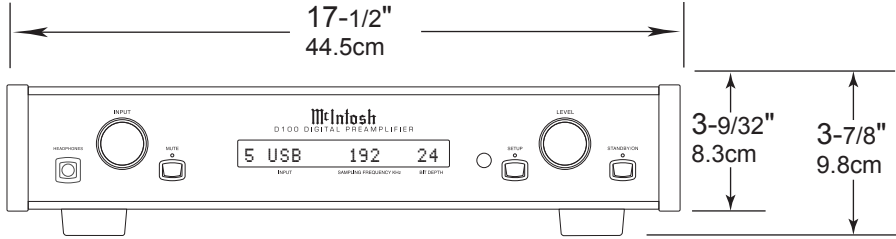

Side View of the D100

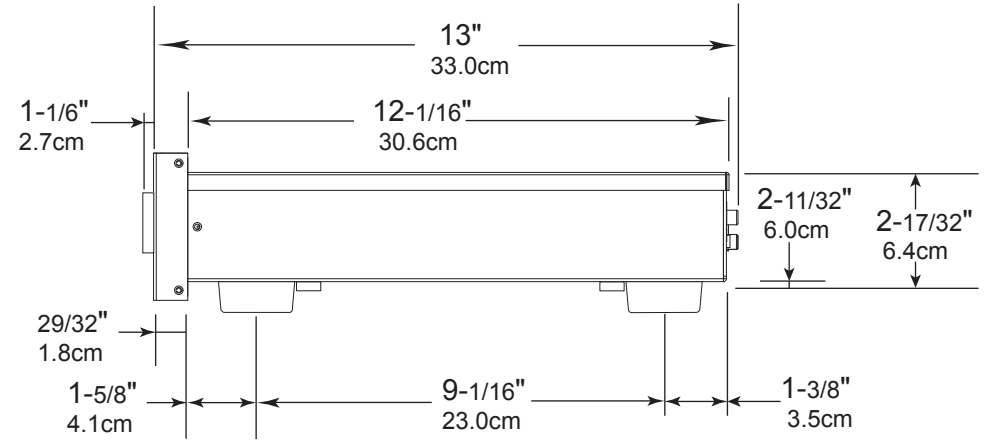

Rear View of the D100

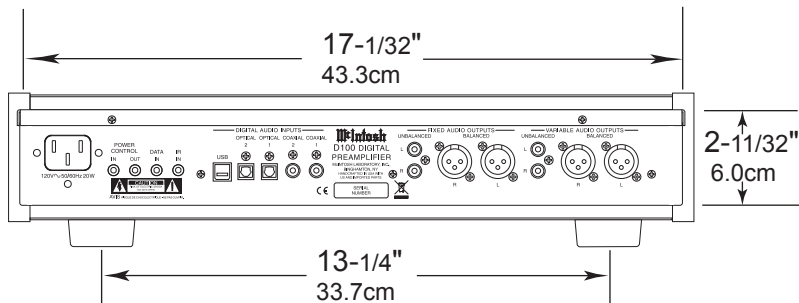

Installation

The D100 can be placed upright on a table or shelf, standing on its four feet. It also can be custom installed in a piece of furniture or cabinet of your choice. The four feet may be removed from the bottom of the D100 when it is custom installed as outlined below. The four feet together with the mounting screws should be retained for possible future use if the D100 is removed from the custom installation and used free standing. The required panel cutout, ventilation cutout and unit dimensions are shown.

Always provide adequate ventilation for your D100. Cool operation ensures the longest possible operating life for any electronic instrument. Do not install the D100 directly above a heat generating component such as a high powered amplifier. If all the components are installed in a single cabinet, a quiet running ventilation fan can be a definite asset in maintaining all the system components at the coolest possible operating temperature.

A custom cabinet installation should provide the following minimum spacing dimensions for cool operation.

Allow at least 2 inches (5.08cm) above the top, 2 inches (5.08cm) below the bottom and 1 inch (2.54cm) on each side of the Preamplifier, so that airflow is not obstructed. Allow 15 inches (38.1cm) depth behind the front panel. Allow 1-7/16 inch (3.66cm) in front of the mounting panel for knob clearance. Be sure to cut out a ventilation hole in the mounting shelf according to the dimensions in the drawing.

**D100 Front Panel
Custom Cabinet Cutout**

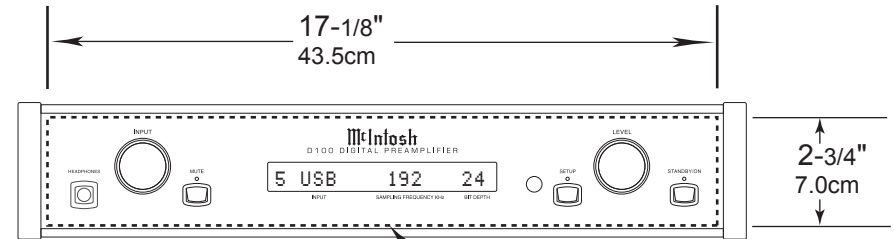

**D100 Side View
in Custom Cabinet**

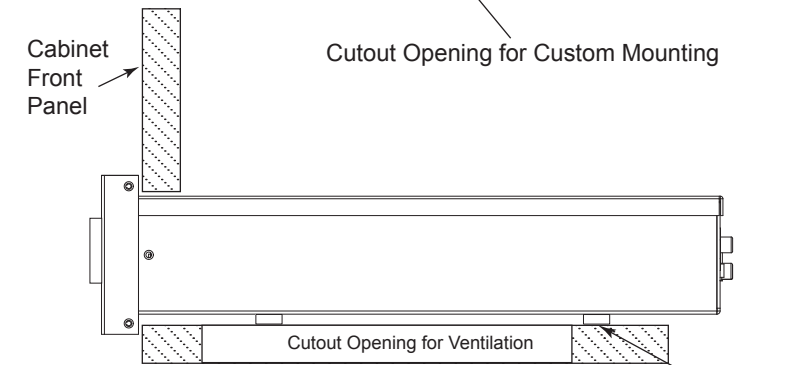

**D100 Bottom View
in Custom Cabinet**

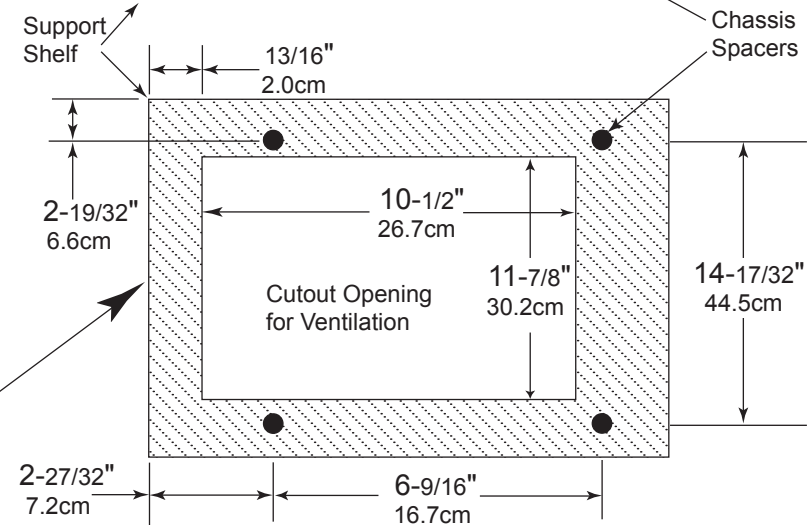

*Note: Center the cutout Horizontally on the unit.
For purposes of clarity, the above illustration is not drawn to scale.*

Connect the D100 power cord to a live AC outlet. Refer to information on the back panel of your D100 to determine the correct voltage for your unit

IR INput for signals from a compatible IR Room Sensor

FIXED AUDIO OUTPUTS UNBALANCED analog audio output signals to a Preamplifier or A/V Control Center

DATA IN receives control data from a McIntosh Preamplifier or A/V Control Center

DIGITAL AUDIO INPUTS OPTICAL INPUTS 2 and 1 for components with a Digital Audio Optical Output

VARIABLE AUDIO OUTPUTS UNBALANCED analog audio output signals to a Power Amplifier

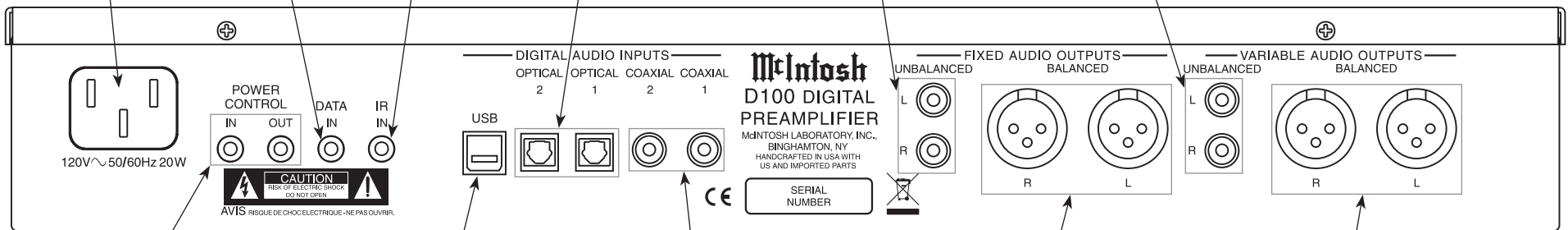

POWER CONTROL IN receives turn-on signals from a McIntosh component. POWER CONTROL OUT sends turn-on signals on to another McIntosh Component.

DIGITAL AUDIO INPUTS COAXIAL Inputs 2 and 1 for components with a Digital Audio Coaxial Output

VARIABLE AUDIO OUTPUTS BALANCED analog audio output signals to a Power Amplifier

USB DIGITAL AUDIO INPUT with control signal for connection to a computer

FIXED AUDIO OUTPUTS BALANCED analog audio output signals to a Preamplifier or A/V Control Center

Connecting to a Power Amplifier

There are two different ways the D100 may be operated in an audio system. The first way as the Main Audio Preamplifier connected directly to a Power Amplifier, instructions on this page. The second way as a Digital to Analog Converter with Input Switching connecting to an Analog Preamplifier, instructions on the next page.

The D100 has the ability to automatically switch power On/Off to Source Components via the Power Control connections. The Data Port Connections allow for the remote operation of basic functions using the D100 Remote Control. With an external sensor connected to the D100, remote control operation of the system is possible from another room and/or when the D100 is located in a cabinet with the doors closed.

The connection instructions below, together with the D100 Connection Diagram located on the separate folded sheet “Mc1A”, is an example of a typical audio system. Your system may vary from this, however the actual components would be connected in a similar manner. For additional information refer to “Connector and Cable Information” on page 4.

Note: The Power Amplifier may be connected to the D100 Balanced or Unbalanced Outputs.

Power Control Connections:

1. Connect a Control Cable from the D100 POWER CONTROL OUT Jack to the Power Control In on the Tuner.
2. Connect a Control Cable from the Tuner Power Control Out Jack to the SACD/CD Player Power Control In Jack.
3. Connect a Control Cable from the SACD/CD Player Power Control Out Jack to the Power Amplifier Power Control In Jack.

Note: If two Power Amplifiers are used, connect the Power Control Output of the first Amplifier to the Power Control Input on the second Amplifier.

4. Connect any additional Components in a similar manner, as outlined in steps 1 thru 3.

Sensor Connection:

5. Optionally, connect the external Sensor to the D100 IR Input Connector.

Audio Connections:

6. Connect balanced audio cables from the D100 VARIABLE AUDIO OUTPUT (R&L) connectors to the balanced Input connectors on the Power Amplifier.

Note: If two Power Amplifiers are used, connect the unbalanced VARIABLE AUDIO OUTPUT (L&R) to the unbalanced Inputs on the second Amplifier.

Digital Audio Connections:

7. Connect a Digital Coaxial Cable from the D100 DIGITAL AUDIO COAXIAL IN 1 Jack to the Tuner Digital Coaxial Output Jack.
8. Connect a Digital Optical Cable from the D100 DIGITAL AUDIO OPTICAL IN 1 Jack to the SACD/CD Player Digital Optical Output Jack.
9. Connect a USB cable with (type A to type B) connectors from the D100 DIGITAL AUDIO INPUT USB to the Computer USB connector.

AC Power Cords Connections:

10. Connect the D100 and any remaining components' AC Power Cords to a live AC outlet as illustrated.





Connecting to an Analog Preamp or A/V Control Center

The D100 has the ability to automatically switch Power On/Off with the Analog Preamp or A/V Control Center via the Power Control connection. The Data Port Connections allow for the remote operation of basic D100 functions using the Analog Preamp Remote Control.

The connection instructions below, together with the D100 Connection Diagram located on the separate folded sheet "Mc1B", is an example of a typical audio system. Your system may vary from this, however the actual components would be connected in a similar manner. For additional information refer to "Connector and Cable Information" on page 4.

Note: The Analog Preamp or A/V Control Center Power may be connected to the D100 Balanced or Unbalanced Outputs.

Power Control Connections:

1. Connect a Control Cable from the Analog Preamp or A/V Control Center to the D100 POWER CONTROL IN Jack.
2. Connect a Control Cable from the D100 POWER CONTROL OUT Jack to the Tuner Power Control In Jack.
3. Connect a Control Cable from the Tuner Power Control Out Jack to the SACD/CD Player Power Control In Jack.
4. Connect any additional Components in a similar manner, as outlined in steps 2 and 3.

Data Connection:

5. Connect a Control Cable from the D100 DATA IN Jack to the Analog Preamp or A/V Control Center DVD or VIDEO Data Port Input.

Sensor Connection:

6. Optionally, connect the external Sensor to the Analog Preamp or A/V Control Center IR Input Connector to the external Sensor.

Audio Connections:

7. Connect balanced audio cables from the D100 FIXED AUDIO OUTPUT (R&L) connectors to the balanced Input connectors on the Analog Preamp or A/V Control Center DVD or VIDEO Input.

Digital Audio Connections:

8. Connect a Digital Coaxial Cable from the D100 DIGITAL AUDIO COAXIAL IN 1 Jack to the Tuner Digital Coaxial Output Jack.
9. Connect a Digital Optical Cable from the D100 DIGITAL AUDIO OPTICAL IN 1 Jack to the SACD/CD Player Digital Optical Output Jack.
10. Connect a USB cable with (type A to type B) connectors from the D100 DIGITAL AUDIO INPUT USB to the Computer USB connector.

AC Power Cords Connections:

11. Connect the D100, Analog Preamp or A/V Control Center and any remaining components' AC Power Cords to a live AC outlet as illustrated.

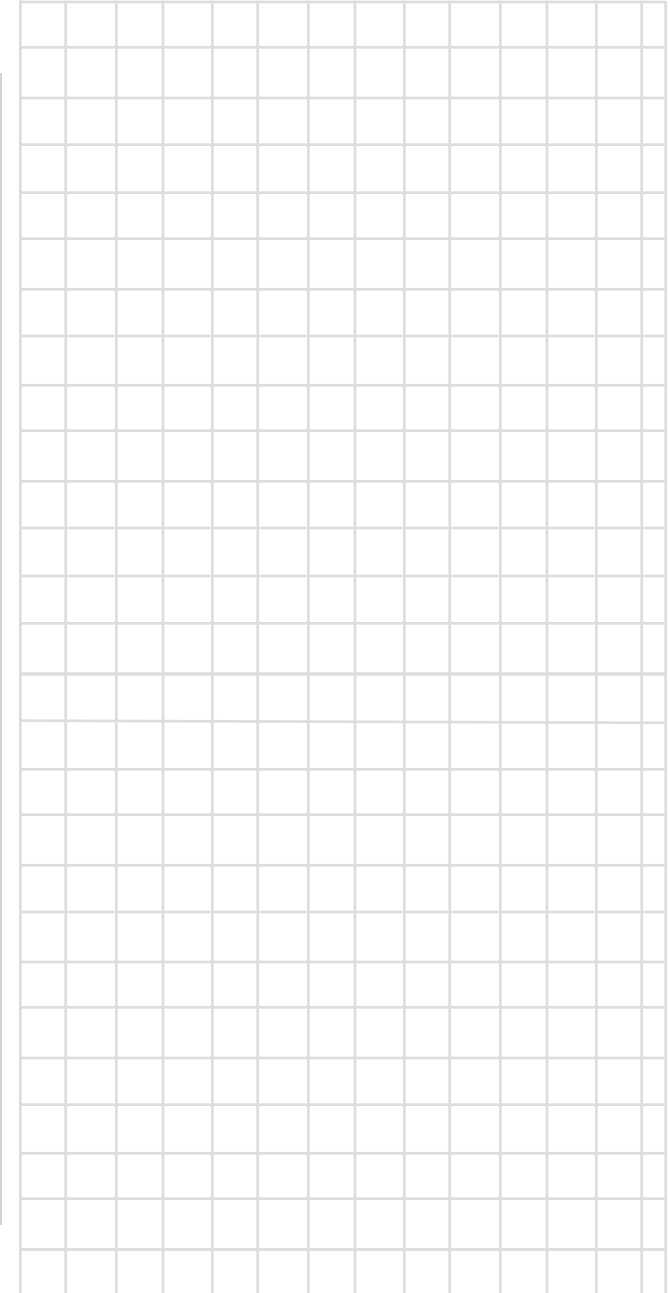

Press the  area of the push-button to switch power On or Off to the D100

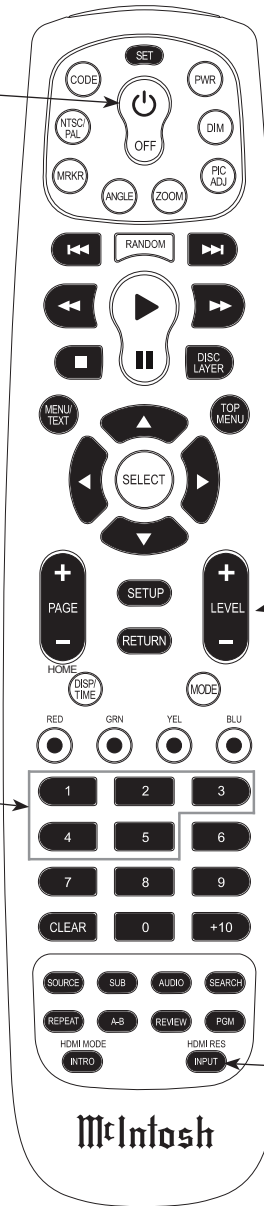

Press the LEVEL Push-button to adjust the Volume Level Up or Down at the D100 Variable Outputs Connections

Direct access to the Digital Input (1 - 5) by using the Front Panel Indicated Input Number for source selection

Steps thru the Digital Inputs (1 - 5) for source selection

Note: Push-buttons whose function is not identified above are for use with other McIntosh Products.

INPUT Control allows the selection of digital sources (1 - 5) for listening

IR Sensor receives commands from a Remote Control

INFORMATION DISPLAY indicates the Source, Volume Level, Sampling Frequency, Bit Depth, Operational Functions and Setup Mode Settings

LEVEL Control allows adjustment of the listening level for both channels

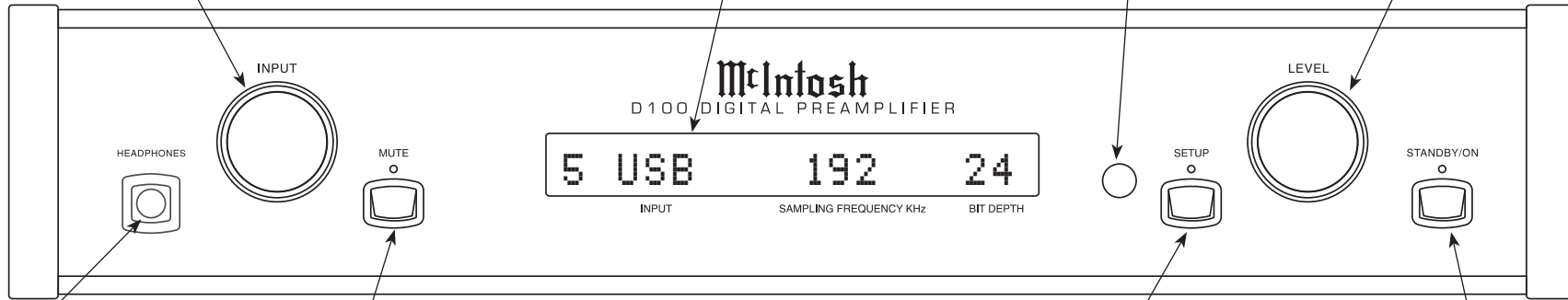

Connection for low impedance dynamic headphones, for private listening

MUTE Push-button with indicator, mutes the audio from the Loudspeakers

SETUP Push-button with indicator, activates the Setup Mode for changing operational settings

STANDBY/ON Push-button with indicator, switches the D100 ON or OFF (Standby) and resets the microprocessors

How to Operate the Setup Mode

Your McIntosh D100 has been factory configured allowing for immediate enjoyment of superb audio. If you wish to make changes to the factory default settings, a Setup Feature is provided to customize the operation by using the Front Panel Information Display. Refer to the D100 Front Panel Illustration on the previous page while performing the following steps.

Note: If the D100 is currently On, proceed to step 2.

1. Press the STANDBY/ON Push-button on the Front Panel or press the  (Power) Push-button on the Remote Control to switch On the D100. The D100 will go through a brief startup initialization with the Front Panel Information Display indicating the Level percentage (Volume) and then the last used Input Source. Refer to figures 1 and 2.

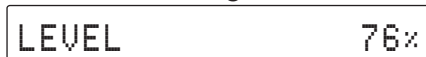

Figure 1

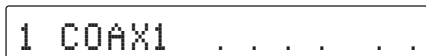

Figure 2

2. Press the SETUP Push-button repeatedly until the Front Panel Information Display indicates “Firmware V1.00” or higher. Refer to figure 3.

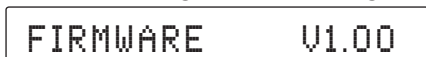

Figure 3

3. Press the SETUP Push-button to exit from the Setup Mode. The LED above the SETUP Push-button will extinguish and the Front Panel Display will revert back to its normal display. Refer to figure 2.

Default Settings

The Default Settings Chart that follows indicates the Function Name, Default Setting and the Page Number for additional information.

Default Settings		
Function Name	Setting	Page No.
AUTO POWER OFF ¹	DISABLED	13
BRIGHTNESS (Display)	HIGH	13
FIRMWARE	V_._._	13

¹In some Countries and/or Localities the default setting of Auto Power Off Feature is ENABLED.

Auto Power Off

The D100 incorporates an Auto Power Off Feature, which can automatically place the Digital Preamplifier into the Power Saving Standby/Off Mode. This occurs approximately 30 minutes after there has been an absence of a Digital Audio Signal on the currently selected D100 Input. If it is desirable to change the current Auto Off Setting (Disabled or Enabled) perform the following steps:

1. Press the SETUP Push-button.
2. The Front Panel Display will momentarily indicate “Auto Power Off”. Refer to figure 4.



Figure 4

3. The display will then indicate the current setting, either Disabled or Enabled. Refer to figures 5 and 6.



Figure 5



Figure 6

4. Rotate the LEVEL Control either clockwise or counterclockwise to change the current setting.
5. Press the SETUP Push-button repeatedly until the LED above the SETUP Push-button is extin-

guished and the Front Panel Information Display indicates the currently selected digital source Input. Refer to figure 2.

Brightness

The Front Panel Information Display Brightness may be changed from the default setting. The D100 will remember the brightness preference, High (default setting) or Low Illumination. Follow the steps below to reduce the Display Brightness:

1. Repeatedly press the SETUP Push-button until “BRIGHTNESS HIGH” is indicated on the Front Panel Information Display. Refer to figure 7.



Figure 7

2. Rotate the LEVEL Control to change the Brightness to the Low Setting. Refer to figure 8.



Figure 8

3. Press the SETUP Push-button repeatedly until the LED above the SETUP Push-button is extinguished and the Front Panel Information Display indicates the currently selected digital source Input. Refer to figure 2.

Firmware Version

The D100 functionality is controlled by internal software known as “Firmware”. The current Version of the Firmware can be identified by utilizing the Setup Mode.

1. Repeatedly press the SETUP Push-button until “FIRMWARE V_._._” is indicated on the Front Panel Information Display. Refer to figure 3.
3. Press the SETUP Push-button until the LED above the SETUP Push-button is extinguished.



How to Operate the D100

Power On and Off

The Red LED above the STANDBY/ON Push-button lights to indicate the D100 is in Standby mode. To switch ON the D100, press the STANDBY/ON Push-button on the Front Panel or the  (Power On) Push-button on the Remote Control. The D100 will go through a brief startup initialization with the Front Panel Information Display indicating the Level Percentage (Volume) and then the last used Input Source. Refer to figures 50, 51, 52 and 53. To switch OFF the



Figure 51

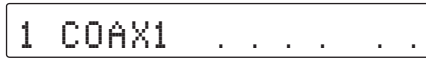

Figure 52

D100 press the STANDBY/ON Push-button on the Front Panel or the  (Power Off) Push-button on the Remote Control.

Source Selection

Rotate the INPUT Control to select the desired source

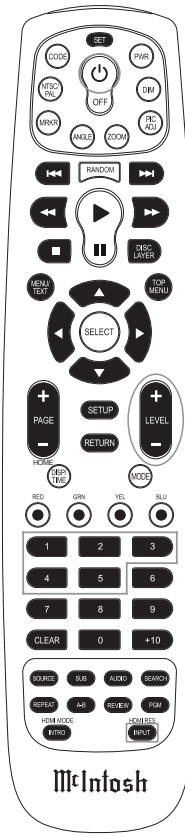



Figure 53

or press the appropriate push-button on the Remote Control. Refer to figures 50 and 53.

Level Control

Rotate the Front Panel LEVEL Control (Volume) or use the LEVEL Up  or Down  Push-buttons on the Remote Control for the desired listening level. Refer to figures 50 and 53.

Mute

Press the MUTE Push-button on the D100 Front Panel to mute the Audio in all outputs except the HEADPHONES Output Jack. Pressing the Mute Push-button a second time will un-mute the D100.

Headphones Jack

Connect a pair of dynamic headphones to the Headphones Jack with a 1/4" (0.635cm) stereo phone type plug for private listening. Press MUTE Push-button to mute the Loudspeakers.

Note: The Headphone Output is optimized for impedances ranging from 20 to 600 ohms.

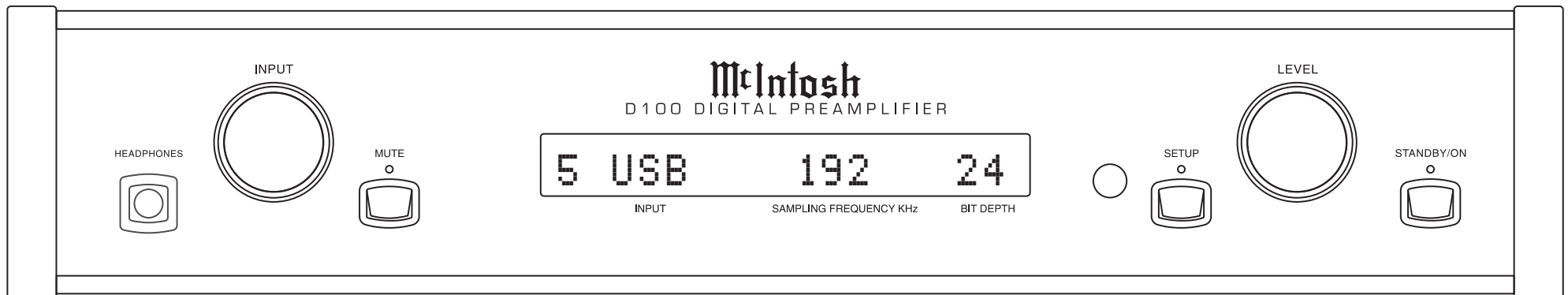

Figure 50

USB Input Operation with a Computer

The D100 USB Input provides the capability to playback music from a computer, when the computer is connected to the rear panel USB connector.

Note: The USB Input is for direct connection to computer only. To playback music from a USB Drive, connect the USB Drive to another USB Port on the computer and select the USB Drive with the Media Playback Program.

The D100 USB Input is compatible with both PC Computers using Microsoft® Windows® (XP with Service Pack 3, Vista with Service Pack 1 and Windows 7) and the Apple® Macintosh® Computers using OS-10.6 with the latest update.

When using a PC Computer with Windows, a special McIntosh USB Audio Software Driver needs to be installed on the PC Computer. The driver needs to be installed before connecting the D100 USB Input to an USB Port on the computer.

Note: If an Apple Macintosh computer is used with the D100, no additional driver is required.

The McIntosh USB Audio Windows Driver and Installation and Operation Guide are available for download from the McIntosh Web Site:

<http://www.mcintoshlabs.com/us/support/Pages/Manuals.aspx>

Under “Product Category” select Preamplifiers and under “Model Number” select D100, then click on “Select”. When the D100 Information appears, download the “McIntosh Audio Windows Driver Installation and Operation Guide” and “McIntosh USB Audio Windows Driver V_ . _”. Follow the instructions in the

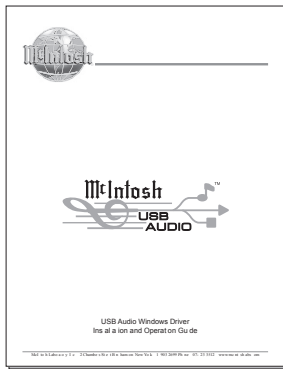

Guide and after the USB Driver is installed, connect the D100 to the PC Computer.

Note: When computer application programs and various computer hardware components conform to the Microsoft® Windows® and Apple® Macintosh® standards they should also work well when used in conjunction with the D100 USB Input. If you are experiencing difficulty with a specific computer hardware component or computer application program, contact the manufacturer of the product.

The D100 Preamplifier Front Panel Information Display will indicate the Sampling Frequency and Bit Depth of the incoming digital signal. Refer to figure 54.



Figure 54

Reset of Microprocessors

In the unlikely event the controls of the D100 stop functioning while On or the D100 will not switch On, the microprocessors can be reset by performing the following:

1. Simultaneously press and hold in the MUTE and SETUP Push-buttons until the LED indicator above the STANDBY/ON Push-button is extinguished.
2. To switch the D100 back on, press the On STANDBY/ON Push-button.



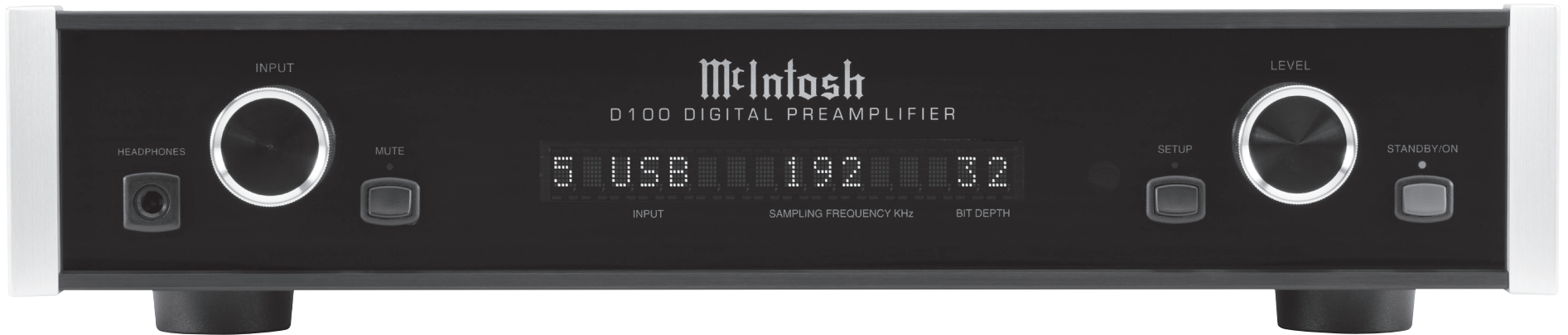





Audio Specifications

Frequency Response

+/-0.5dB from 4Hz to 20,000Hz

+0.5/-3dB from 4Hz to 68,000Hz (Source dependent)

Total Harmonic Distortion

0.0015%

Fixed Output level

2.0Vrms Unbalanced

4.0Vrms Balanced

Variable Output level

0 - 8.0Vrms Unbalanced

0- 16.0Vrms Balanced

Signal To Noise Ratio (A-Weighted)

110dB

Dynamic Range

100dB

Output Impedance

600 ohms Unbalanced and Balanced

Headphone Load Impedance

20 to 600 ohms

Digital Audio Specifications

Digital Input Format

SPDIF (PCM¹)

Digital Input Sample Rate

Coaxial and Optical: Up to 192KHz, 24-Bit

USB: Up to 192KHz, 32-Bit

Digital Inputs

Coaxial 1 and 2: 0.5V p-p/75 ohms

Optical 1 and 2: - 15dbm to -21dbm (TOS Link)

USB: USB Type B Connector

¹ PCM (Pulse Code Modulation) Digital Signal type used for CD Discs, etc.

General Specifications

Power Control

12VDC, 25mA

Power Requirements

Field AC Voltage conversion of the D100 is not possible. The D100 is factory configured for one of the following AC Voltages:

100 Volts, 50/60Hz at 20 watts

110 Volts, 50/60Hz at 20 watts

120 Volts, 50/60Hz at 20 watts

220 Volts, 50/60Hz at 20 watts

230 Volts, 50/60Hz at 20 watts

240 Volts, 50/60Hz at 20 watts

Standby Power, less than 0.25 watts

Note: Refer to the rear panel of the D100 for the correct voltage.

Overall Dimensions

Width is 17-1/2 inches (44.45cm)

Height is 3-7/8 inches (9.8cm) including feet

Depth is 16 inches (40.64cm) including the Front

Panel, Knobs and Cables

Weight

13.5 pounds (6.1 kg) net, 28 pounds (12.7 kg) in shipping carton

Shipping Carton Dimensions

Width is 26-1/2 inches (67.3cm)

Height is 11-3/4 inches (29.9cm)

Depth is 24-1/4 inches (62.2cm)

Packing Instructions

In the event it is necessary to repack the equipment for shipment, the equipment must be packed exactly as shown below. It is very important that the four plastic feet are attached to the bottom of the equipment.

This will ensure the proper equipment location on the bottom pad. Failure to do this will result in shipping damage.

Use the original shipping carton and interior parts only if they are all in good serviceable condition. If a shipping carton or any of the interior part(s) are needed, please call or write Customer Service Department of McIntosh Laboratory. Refer to page 4. Please see the Part List for the correct part numbers.

Quantity	Part Number	Description
1	033838	Shipping carton only
4	033837	End cap
1	033836	Inside carton only
1	033725	Top pad
1	034301	Bottom pad
1	034547	Bottom filler pad
2	034446	Foam plug
4	017937	Plastic foot
4	400159	#10-32 x 3/4" screw
4	404080	#10 Flat washer

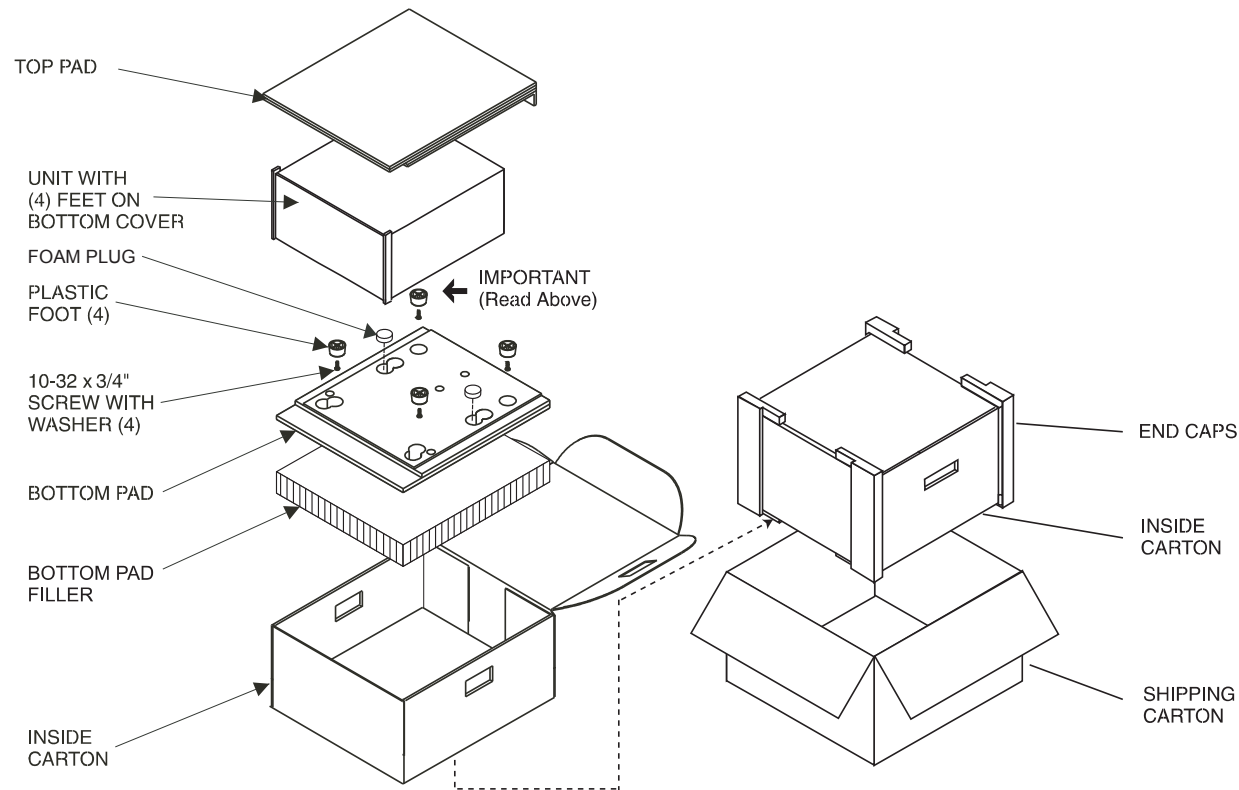



McIntosh Laboratory, Inc.
2 Chambers Street
Binghamton, NY 13903
www.mcintoshlabs.com

The continuous improvement of its products is the policy of McIntosh Laboratory Incorporated who reserve the right to improve design without notice.
Printed in the U.S.A.